

HEAD EXPANDER
 ON SERIES 100
 DOUBLE HUNG

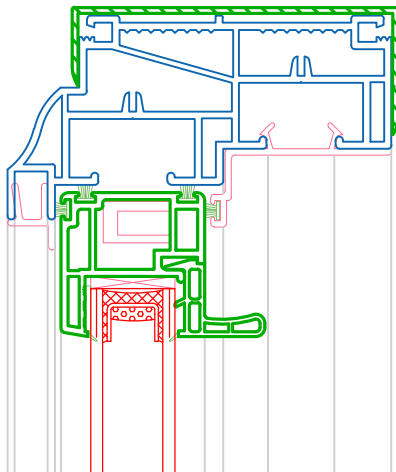

HEAD EXPANDER
 ON SERIES 200
 DOUBLE HUNG

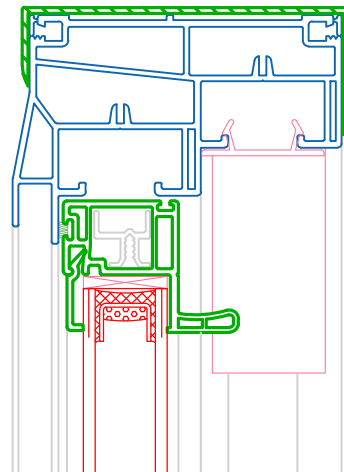

HEAD EXPANDER
 ON SERIES 500
 DOUBLE HUNG

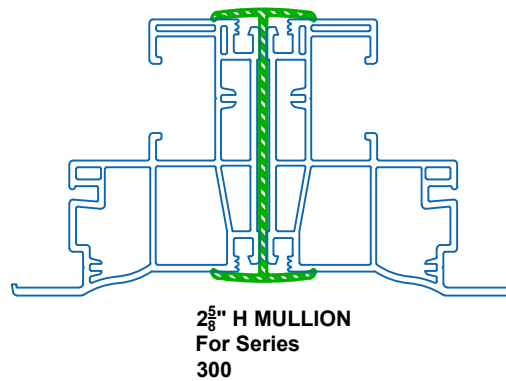
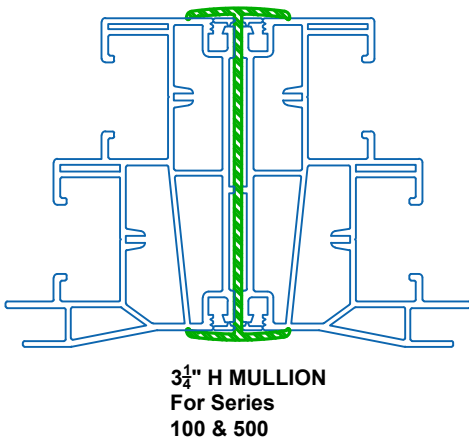
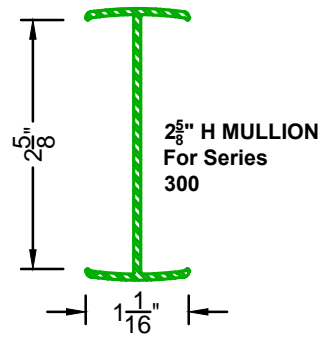
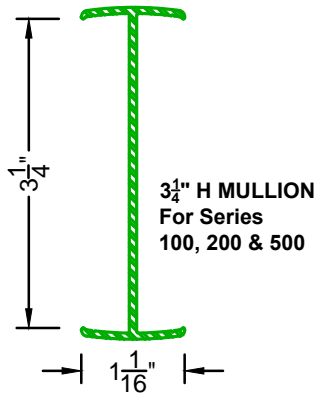
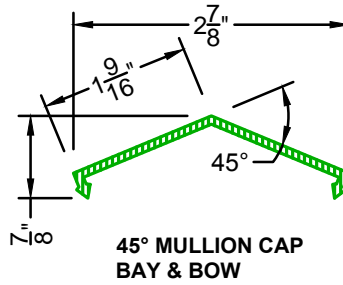
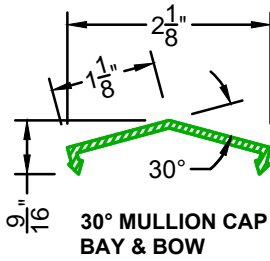
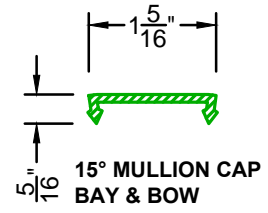
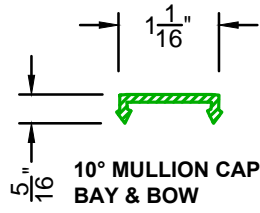
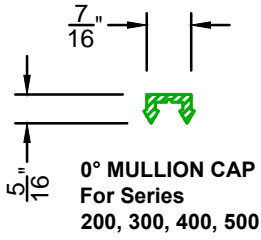

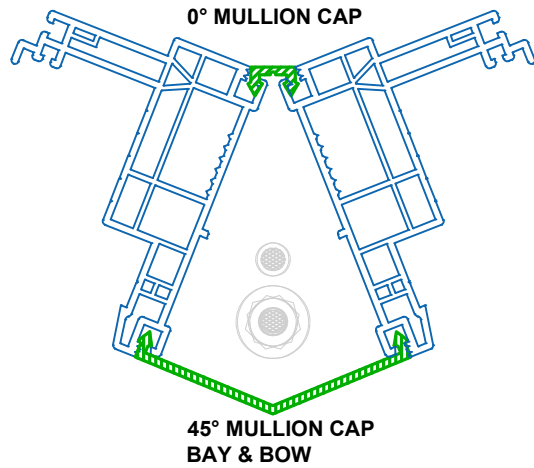
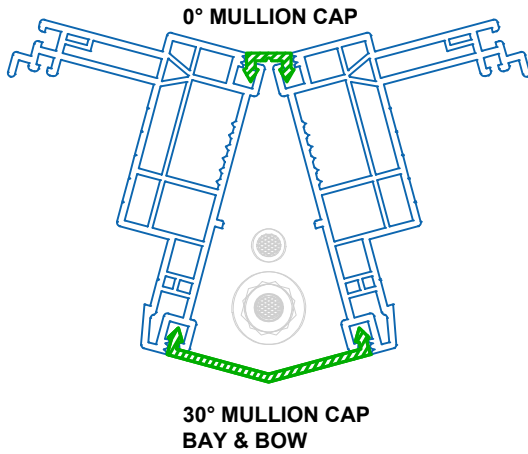
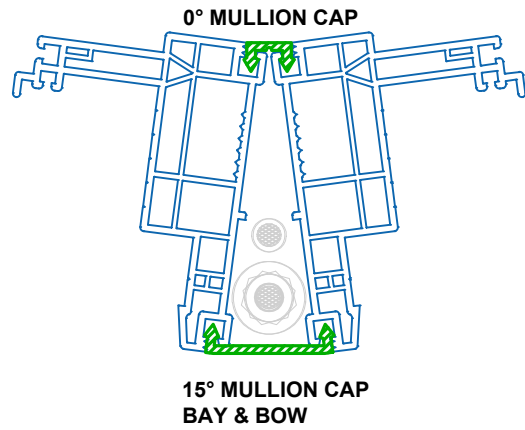
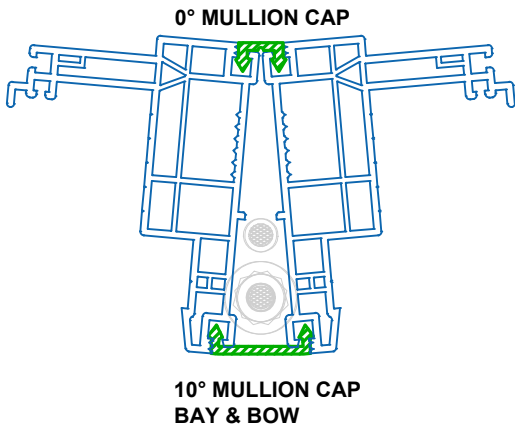
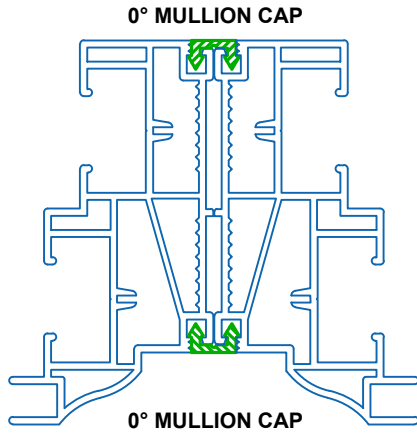

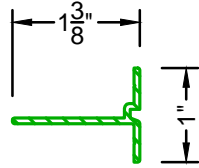

**NAILING FIN
 FOR SERIES
 100, 200 & 500**

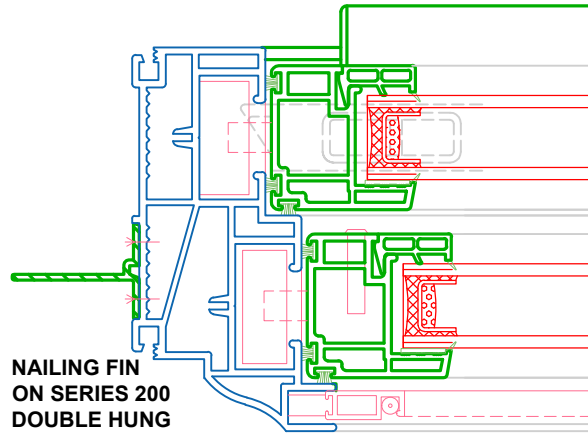

**NAILING FIN
 ON SERIES 200
 DOUBLE HUNG**

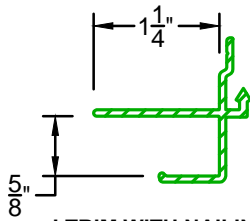

**J TRIM WITH NAILING FIN
 FOR SERIES 200 & 500**

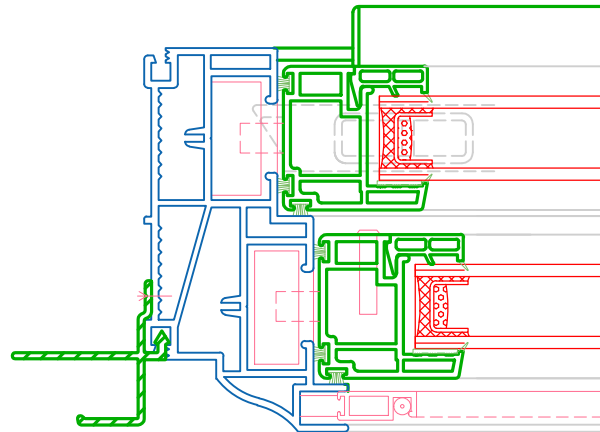

**J TRIM WITH NAILING FIN
 ON SERIES 200 DOUBLE HUNG**

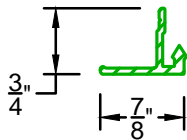

**J TRIM
 FOR SERIES 300**

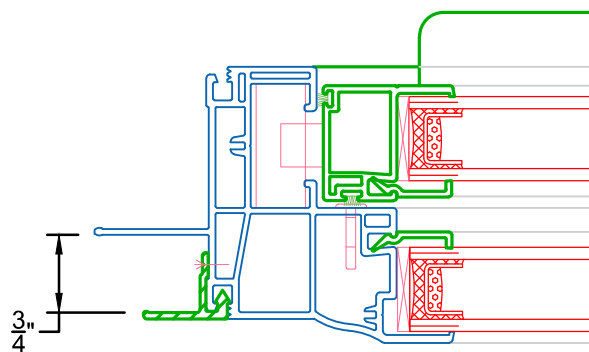

**J TRIM ON SERIES 300
 DOUBLE HUNG**

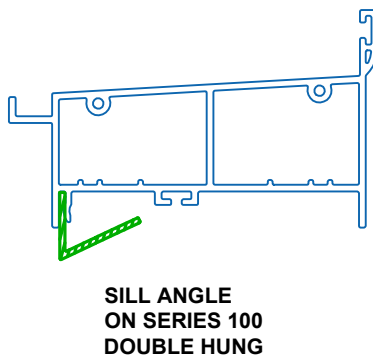
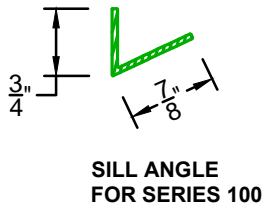
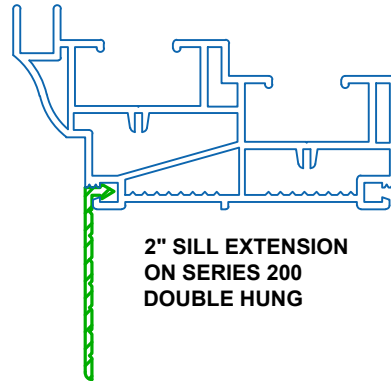
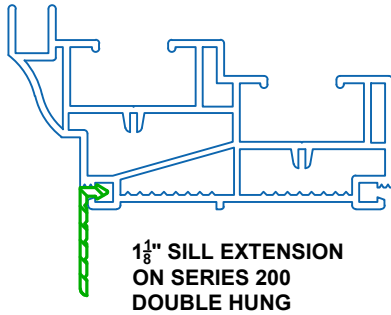
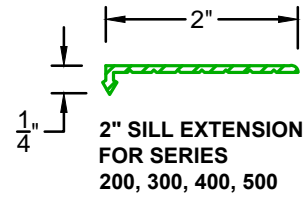
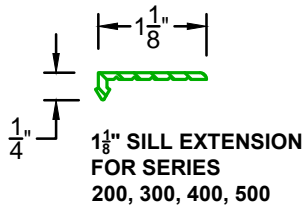

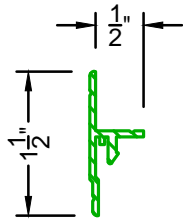

WOOD JAMB EXTENSION
 FOR SERIES 300 & 400

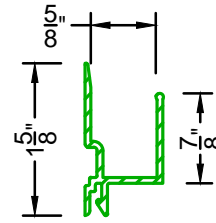

DRYWALL RETURN
 FOR SERIES 200, 300 & 400

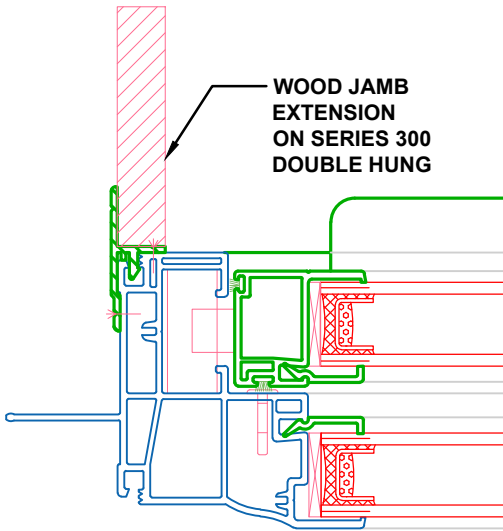

WOOD JAMB
 EXTENSION
 ON SERIES 300
 DOUBLE HUNG

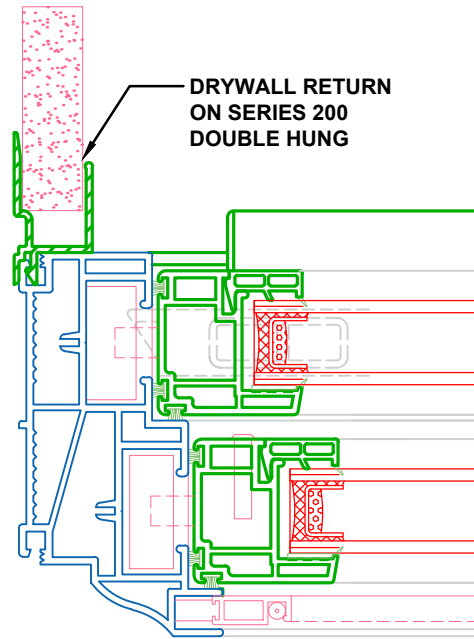

DRYWALL RETURN
 ON SERIES 200
 DOUBLE HUNG

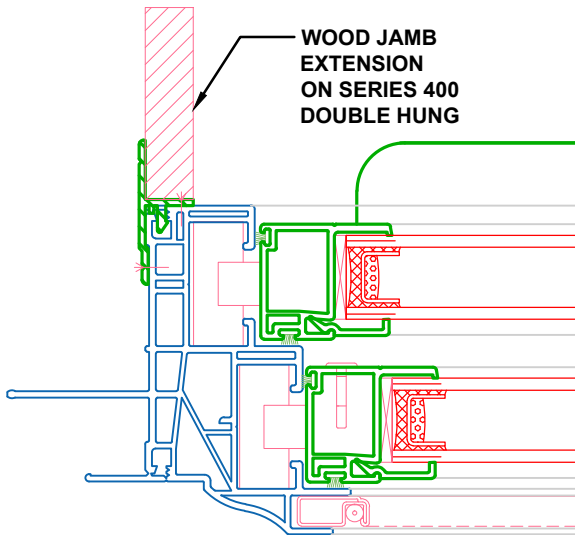

WOOD JAMB
 EXTENSION
 ON SERIES 400
 DOUBLE HUNG